

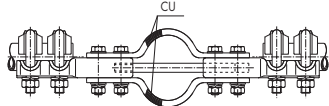

**CONECTORES DE DILATACIÓN / EXPANSION CONNECTORS / RACCORDS SOUPLES**



**RFBB**

▶ Pag. G1

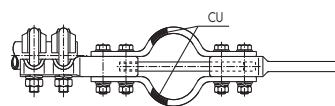

**RFBP**

▶ Pag. G1

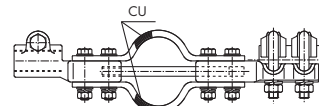

**RFBRB-FIG. 1**

▶ Pag. G2

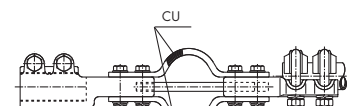

**RFBRB-FIG. 2**

▶ Pag. G2

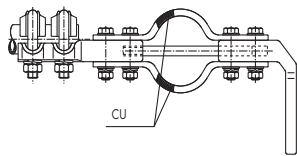

**LFBB**

▶ Pag. G3

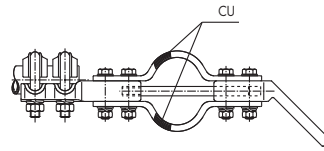

**LFBP45**

▶ Pag. G3

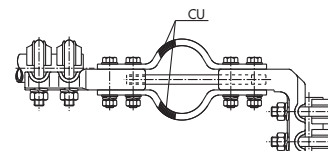

**LFBB**

▶ Pag. G3

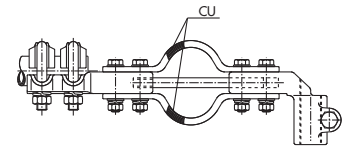

**LFBBR-FIG. 1**

▶ Pag. G4

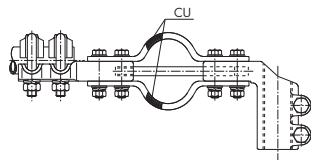

**LFBBR-FIG. 2**

▶ Pag. G4

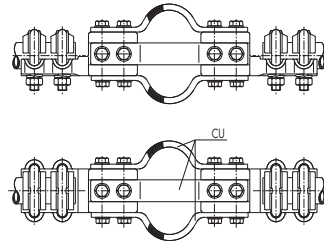

**RFBFB4**

▶ Pag. G4

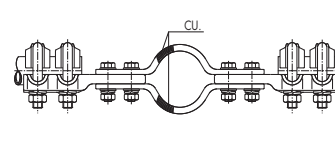

**RFBFB2**

▶ Pag. G5

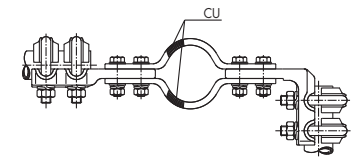

**LFBB2**

▶ Pag. G5

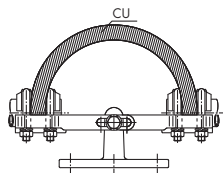

**PEFBC**

▶ Pag. G6

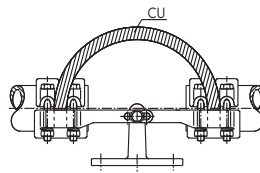

**PEFBC**

▶ Pag. G6

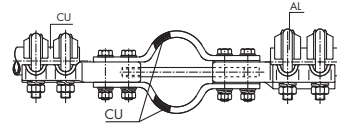

**XRFBB**

▶ Pag. G7

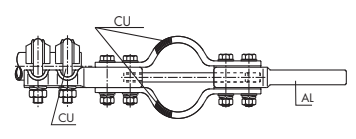

**XRFBP**

▶ Pag. G7

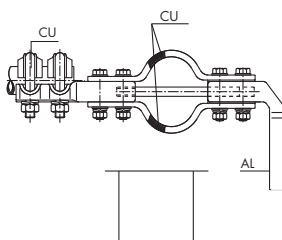

**XLFBB**

▶ Pag. G8

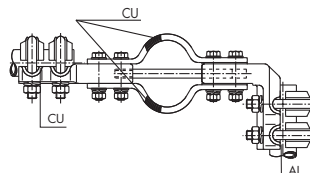

**XLFBB**

▶ Pag. G8



**FPP**

▶ Pag. G9

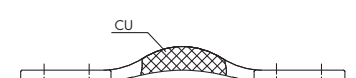

**TPP**

▶ Pag. G9

EXPANSION STRAIGHT CONNECTOR WITH GUIDE FOR CU. TUBES UNION

CONECTOR RECTO DE DILATACIÓN CON GUIA PARA UNIÓN DE TUBOS DE CU.

RACCORD DROIT SOUPLE AVEC GUIDE POUR JONCTION DE TUBES DE CU.

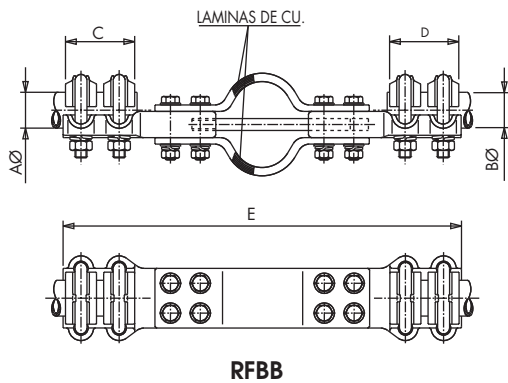

Referencia Code Référence	m m .					Par de apriete Tightening torque Couple de serrage (kg.m)	
	AØ	BØ	C	D	E	A	B
	RFBB-3020	30	20	62	52	318	3
RFBB-3025	30	25	62	55	322	3	2
RFBB-3030	30	30	62	62	335	3	3
RFBB-3040	30	40	62	67	340	3	3
RFBB-3050	30	50	62	75	358	3	3
RFBB-3060	30	60	62	80	360	3	3
RFBB-4025	40	25	67	55	330	3	2
RFBB-4040	40	40	67	67	350	3	3
RFBB-4050	40	50	67	75	363	3	3
RFBB-4060	40	60	67	80	365	3	3
RFBB-5050	50	50	75	75	370	3	3
RFBB-5060	50	60	75	80	372	3	3
RFBB-6060	60	60	80	80	375	3	3

EXPANSION STRAIGHT CONNECTOR WITH GUIDE TUBE TO FLATBAR

CONECTOR RECTO DE DILATACIÓN CON GUIA DE TUBO A PALA

RACCORD DROIT SOUPLE AVEC GUIDE DE TUBE À BARRE MÉPLATE

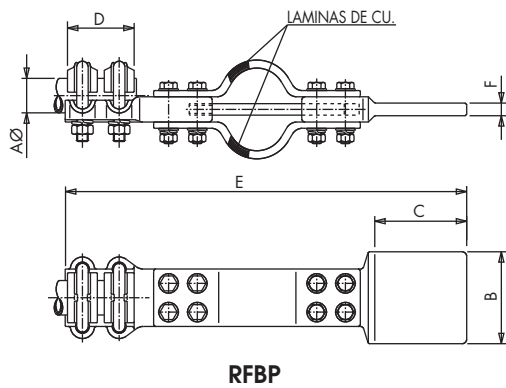

Referencia Code Référence	m m .						Par de apriete Tightening torque Couple de serrage (kg.m)
	AØ	B	C	D	E	F	
	RFBP-2033	20	50	50	52	310	8
RFBP-2522	25	40	40	55	303	8	2
RFBP-2533	25	50	50	55	310	8	2
RFBP-2535	25	50	80	55	340	8	2
RFBP-2544	25	60	60	55	320	8	2
RFBP-2555	25	80	80	55	340	8	2
RFBP-3033	30	50	50	62	325	10	3
RFBP-3035	30	50	80	62	355	10	3
RFBP-3044	30	60	60	62	335	10	3
RFBP-3055	30	80	80	62	355	10	3
RFBP-3066	30	100	100	62	375	10	3
RFBP-4033	40	50	50	67	335	10	3
RFBP-4035	40	50	80	67	365	10	3
RFBP-4044	40	60	60	67	345	10	3
RFBP-4055	40	80	80	67	365	10	3
RFBP-4066	40	100	100	67	385	10	3
RFBP-5033	50	50	50	75	345	10	3
RFBP-5035	50	50	80	75	375	10	3
RFBP-5044	50	60	60	75	355	10	3
RFBP-5055	50	80	80	75	375	10	3
RFBP-5066	50	100	100	75	395	10	3
RFBP-6033	60	50	50	80	350	12	3
RFBP-6035	60	50	80	80	380	12	3
RFBP-6044	60	60	60	80	360	12	3
RFBP-6055	60	80	80	80	360	10	3
RFBP-6066	60	100	100	80	400	10	3

FIG.1

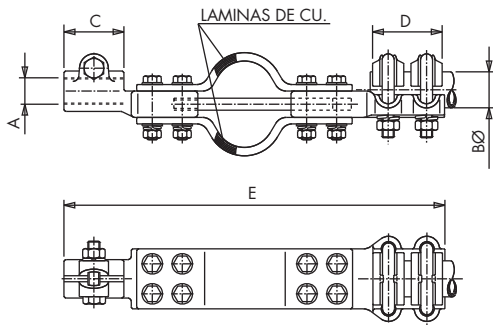

RFBRB  
FIG. 1

Referencia Code Référence	m m .					Par de apriete Tightening torque Couple de serrage (kg.m)
	A	BØ	C	D	E	
RFBRB-M1630	M-16	30	40	62	315	3
RFBRB-M1640	M-16	40	40	67	320	3
RFBRB-M1650	M-16	50	40	75	328	3
RFBRB-M1660	M-16	60	40	80	333	3
RFBRB-M2030	M-20	30	50	62	325	3
RFBRB-M2040	M-20	40	50	67	330	3
RFBRB-M2050	M-20	50	50	75	338	3
RFBRB-M2060	M-20	60	50	80	343	3

FIG.2

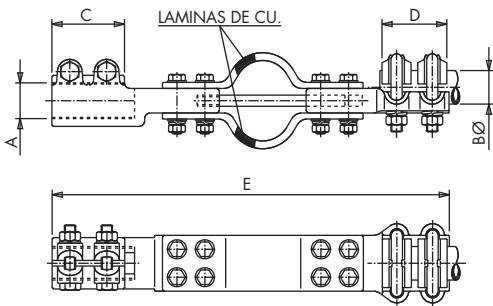

RFBRB  
FIG. 2

Referencia Code Référence	m m .					Par de apriete Tightening torque Couple de serrage (kg.m)
	A	BØ	C	D	E	
RFBRB-M3030	M-30	30	75	62	340	3
RFBRB-M3040	M-30	40	75	67	345	3
RFBRB-M3050	M-30	50	75	75	353	3
RFBRB-M3060	M-30	60	75	80	362	3

90°/45° EXPANSION CONNECTOR WITH GUIDE FOR UNION CU. TUBE TO FLAT

CONECTOR A 90°/45° DE DILATACIÓN CON GUIA PARA UNIÓN TUBO CU. A PALA

RACCORD À 90°/45° SOUPLE AVEC GUIDE POUR JONCTION TUBE CU. À PLAGE

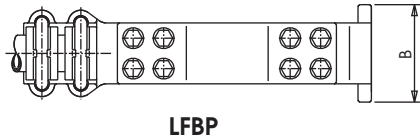
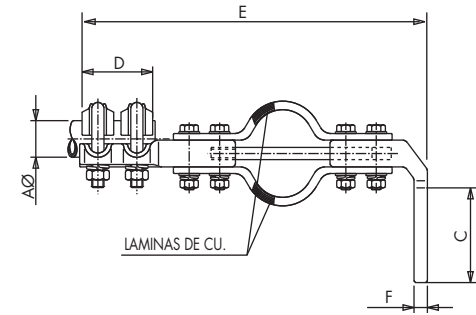

LFBP

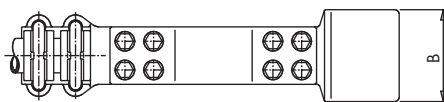
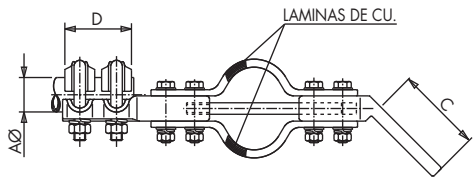

LFBP45

Referencia Code Référéce	m m .						Par de apriete Tightening torque Couple de serrage (kg.m)
	AØ	B	C	D	E	F	
	LFBP-2033	20	50	50	52	268	
LFBP-2522	25	40	40	55	271	8	2
LFBP-2533	25	50	50	55	268	8	2
LFBP-2535	25	50	80	55	268	8	2
LFBP-2544	25	60	60	55	268	8	2
LFBP-2555	25	80	80	55	268	8	2
LFBP-3033	30	50	50	62	285	10	3
LFBP-3035	30	50	80	62	285	10	3
LFBP-3044	30	60	60	62	285	10	3
LFBP-3055	30	80	80	62	285	10	3
LFBP-3066	30	100	100	62	285	10	3
LFBP-4033	40	50	50	67	295	10	3
LFBP-4035	40	50	80	67	295	10	3
LFBP-4044	40	60	60	67	295	10	3
LFBP-4055	40	80	80	67	295	10	3
LFBP-4066	40	100	100	67	295	10	3
LFBP-5033	50	50	50	75	307	12	3
LFBP-5035	50	50	80	75	307	12	3
LFBP-5044	50	60	60	75	305	10	3
LFBP-5055	50	80	80	75	305	10	3
LFBP-5066	50	100	100	75	305	10	3
LFBP-6033	60	50	50	80	312	12	3
LFBP-6035	60	50	80	80	312	12	3
LFBP-6044	60	60	60	80	312	12	3
LFBP-6055	60	80	80	80	310	10	3
LFBP-6066	60	100	100	80	310	10	3

NOTA: OTROS ÁNGULOS A INDICAR

NOTE: SPECIFY ANOTHER ANGLES

NOTE: D'AUTRES ANGLES À PRECISER

EXPANSION L CONNECTOR WITH GUIDE FOR UNION CU. TUBES

CONECTOR A 90° DE DILATACIÓN CON GUIA PARA UNIÓN DE TUBOS DE CU.

RACCORD EQUERRE SOUPLE AVEC GUIDE POUR JONCTION DE TUBES CU.

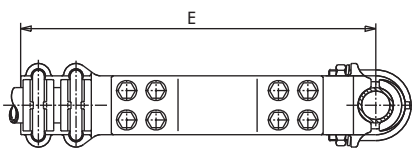
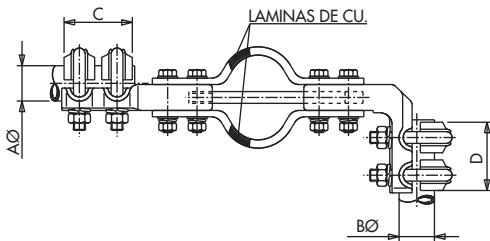

LFBB

Referencia Code Référéce	m m .					Par de apriete Tightening torque Couple de serrage (kg.m)	
	AØ	BØ	C	D	E	A	B
	LFBB-3020	30	20	62	52	282	3
LFBB-3025	30	25	62	52	285	3	2
LFBB-3030	30	30	62	62	288	3	3
LFBB-4025	40	25	67	55	292	3	2
LFBB-4030	40	30	67	62	302	3	3
LFBB-4040	40	40	67	67	307	3	3
LFBB-5030	50	30	75	62	320	3	3
LFBB-5040	50	40	75	67	325	3	3
LFBB-6030	60	30	80	62	322	3	3
LFBB-6040	60	40	80	67	325	3	3
LFBB-6050	60	50	80	75	330	3	3

EXPANSION L CONNECTOR WITH GUIDE SCREWED STUD TO TUBE

CONECTOR A 90° DE DILATACIÓN CON GUIA PARA UNIÓN DE BORNA ROSCADA A TUBO

RACCORD EQUERRE SOUPLE AVEC GUIDE DE BORNE VISSÉ À TUBE

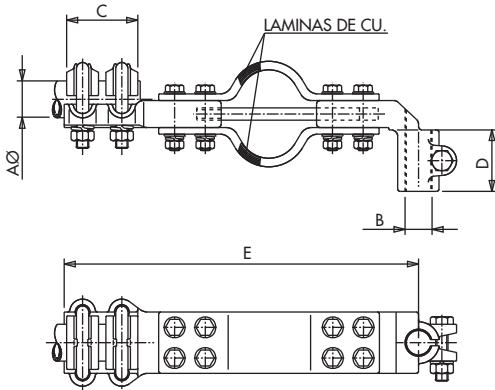

LFBBR  
FIG. 1

FIG. 1

Referencia Code Référence	m m .					Par de apriete Tightening torque Couple de serrage (kg.m)
	Aø	B	C	D	E	
LFBBR-30M16	30	M-16	62	40	270	3
LFBBR-40M16	40	M-16	67	40	282	3
LFBBR-50M16	50	M-16	75	40	310	3
LFBBR-60M16	60	M-16	80	40	312	3
LFBBR-30M20	30	M-20	62	50	275	3
LFBBR-40M20	40	M-20	67	50	287	3
LFBBR-50M20	50	M-20	75	50	315	3
LFBBR-60M20	60	M-20	80	50	317	3

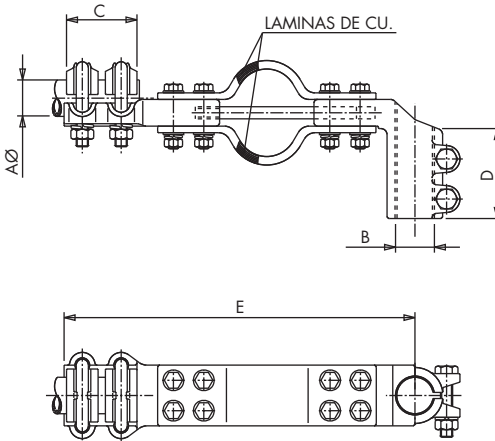

LFBBR  
FIG. 2

FIG. 2

Referencia Code Référence	m m .					Par de apriete Tightening torque Couple de serrage (kg.m)
	Aø	B	C	D	E	
LFBBR-30M30	30	M-30	62	75	285	3
LFBBR-40M30	40	M-30	67	75	297	3
LFBBR-50M30	50	M-30	75	75	325	3
LFBBR-60M30	60	M-30	80	75	327	3

EXPANSION STRAIGHT CONNECTOR FOR UNION CU. TUBE/STUD TO TUBE

CONECTOR RECTO DE DILATACIÓN PARA UNIÓN TUBO/BORNA CU. A TUBO

RACCORD DROIT SOUPLE POUR JONCTION TUBE/BORNE CU. À TUBE

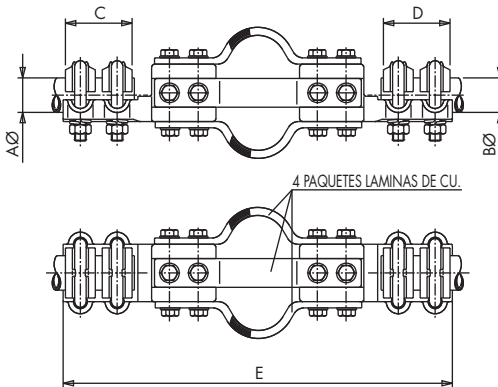

RFBB4

Referencia Code Référence	m m .					Par de apriete Tightening torque Couple de serrage (kg.m)
	Aø	Bø	C	D	E	
RFBB4-3030	30	30	62	62	336	3
RFBB4-3040	30	40	62	67	342	3
RFBB4-4040	40	40	67	67	346	3

**EXPANSION STRAIGHT CONNECTOR FOR UNION OF CU. TUBES (WITHOUT GUIDE)**

**CONECTOR RECTO DE DILATACIÓN PARA UNIÓN DE TUBOS CU. (SIN GUIA)**

**RACCORD DROIT SOUPLE POUR JONCTION DE TUBES CU. (SANS GUIDE)**

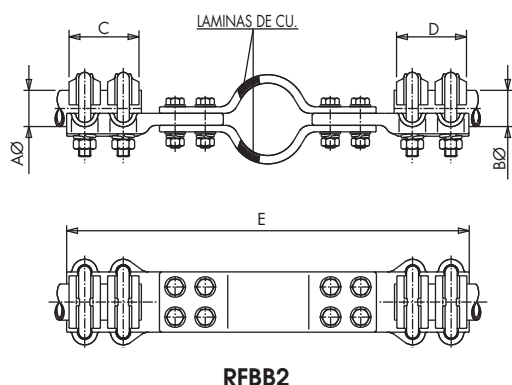

Referencia Code	m m .					Par de apriete Tightening torque Couple de serrage (kg.m)	
	AØ	BØ	C	D	E	A	B
	RFBB2-3020	30	20	62	52	318	3
RFBB2-3025	30	25	62	55	322	3	2
RFBB2-3030	30	30	62	62	335	3	3
RFBB2-3040	30	40	62	67	340	3	3
RFBB2-3050	30	50	62	75	358	3	3
RFBB2-3060	30	60	62	80	360	3	3
RFBB2-4025	40	25	67	55	330	3	2
RFBB2-4040	40	40	67	67	350	3	3
RFBB2-4050	40	50	67	75	363	3	3
RFBB2-4060	40	60	67	80	365	3	3
RFBB2-5050	50	50	75	75	370	3	3
RFBB2-5060	50	60	75	80	372	3	3
RFBB2-6060	60	60	80	80	375	3	3

**EXPANSION L CONNECTOR FOR UNION OF CU. TUBES (WITHOUT GUIDE)**

**CONECTOR A 90° DE DILATACIÓN PARA UNIÓN DE TUBOS CU. (SIN GUIA)**

**RACCORD EQUERRE SOUPLE POUR JONCTION DE TUBES CU. (SANS GUIDE)**

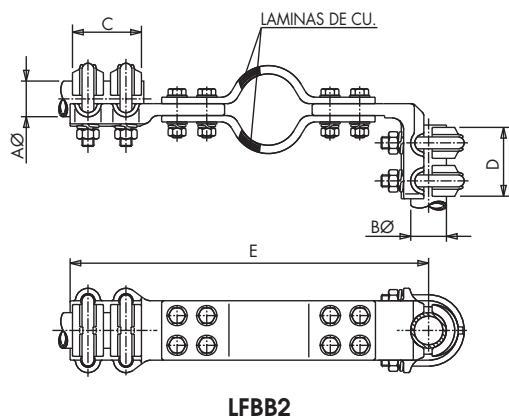

Referencia Code Référence	m m .					Par de apriete Tightening torque Couple de serrage (kg.m)	
	AØ	BØ	C	D	E	A	B
	LFBB2-3020	30	20	62	52	282	3
LFBB2-3025	30	25	62	52	285	3	2
LFBB2-3030	30	30	62	62	288	3	3
LFBB2-4025	40	25	67	55	292	3	2
LFBB2-4030	40	30	67	62	302	3	3
LFBB2-4040	40	40	67	67	307	3	3
LFBB2-5030	50	30	75	62	320	3	3
LFBB2-5040	50	40	75	67	325	3	3
LFBB2-6030	60	30	80	62	322	3	3
LFBB2-6040	60	40	80	67	325	3	3
LFBB2-6050	60	50	80	75	330	3	3

EXPANSION SUPPORT FOR UNION CU. TUBES MOUNTED ON INSULATOR

PORTATUBOS DE DILATACIÓN PARA UNIÓN TUBOS CU. MONTADOS SOBRE AISLADOR

SUPPORT À DILATATION POUR JONCTION TUBES CU. SUR PILLARD

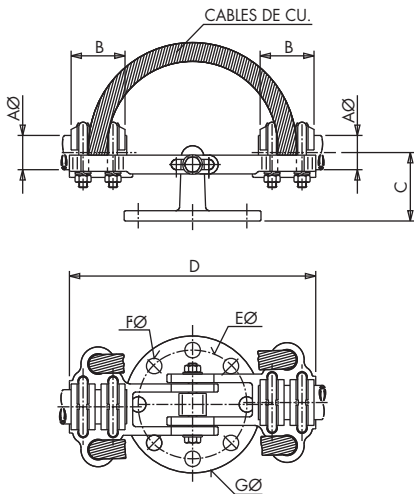

PEFBC

Referencia Code Référéce	m m .							Par de apriete Tightening torque Couple de serrage (kg.m)
	AØ	B	C	D	EØ	FØ	GØ	
PEFBC-303076	30	62	80	285	76	14	108	3
PEFBC-404076	40	67	80	290	76	14	108	3
PEFBC-505076	50	75	80	300	76	14	108	3
PEFBC-606076	60	80	100	310	76	14	108	3
PEFBC-3030127	30	62	80	285	127	18	158	3
PEFBC-4040127	40	67	80	290	127	18	158	3
PEFBC-5050127	50	75	80	300	127	18	158	3
PEFBC-6060127	60	80	100	310	127	18	158	3

EXPANSION SUPPORT FOR UNION CU. TUBES MOUNTED ON INSULATOR

PORTATUBOS DE DILATACIÓN PARA UNIÓN TUBOS CU. MONTADOS SOBRE AISLADOR

SUPPORT À DILATATION POUR JONCTION TUBES CU. SUR PILLARD

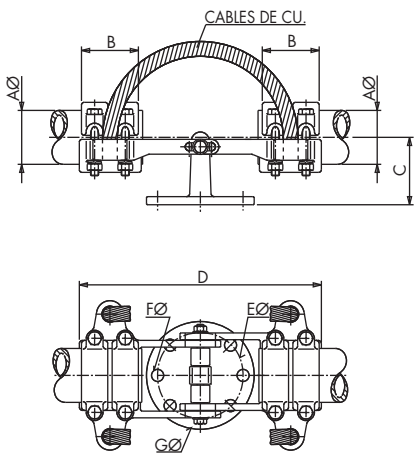

PEFBC

Referencia Code Référéce	m m .							Par de apriete Tightening torque Couple de serrage (kg.m)
	AØ	B	C	D	EØ	FØ	GØ	
PEFBC-808076	80	90	100	365	76	14	108	5
PEFBC-8080127	80	90	100	365	127	18	158	5

**BIMETALLIC EXPANSION STRAIGHT CONNECTOR GUIDED UNION CU. TUBE/STUD TO AL. TUBE**

**CONECTOR RECTO DE DILATACIÓN BIMETÁLICO GUIADO UNIÓN TUBO/BORNA CU. A TUBO AL.**

**RACCORD DROIT SOUPLE BIMETALLIQUE GUIÉE JONCTION TUBE/BORNE CU. À TUBE AL.**

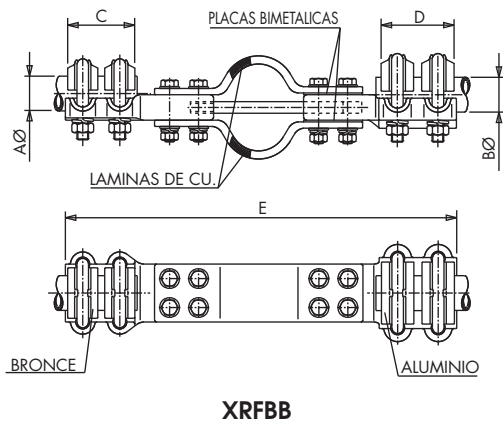

Referencia Code Référence	m m .					Par de apriete Tightening torque Couple de serrage (kg.m)
	AØ	BØ	C	D	E	
XRFBB-3030AL	30	30	62	67	340	3
XRFBB-3040AL	30	40	62	75	358	3
XRFBB-3050AL	30	50	62	80	360	3
XRFBB-4030AL	40	30	67	67	350	3
XRFBB-4040AL	40	40	67	75	363	3
XRFBB-4050AL	40	50	67	80	365	3
XRFBB-5030AL	50	30	75	67	363	3
XRFBB-5040AL	50	40	75	75	370	3
XRFBB-5050AL	50	50	75	80	373	3

**BIMETALLIC EXPANSION STRAIGHT CONNECTOR GUIDED UNION CU. TUBE/STUD TO AL. FLATBAR**

**CONECTOR RECTO DE DILATACIÓN BIMETÁLICO GUIADO UNIÓN TUBO/BORNA CU. A PLETINA AL.**

**RACCORD DROIT SOUPLE BIMETALLIQUE GUIÉE JONCTION TUBE/BORNE CU. À BARRE MÉPLATE AL.**

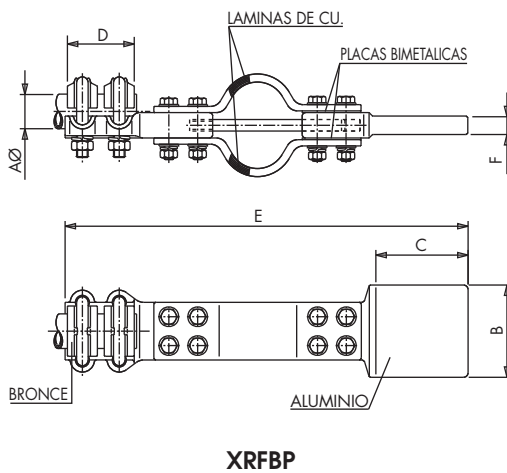

Referencia Code Référence	m m .						Par de apriete Tightening torque Couple de serrage (kg.m)
	AØ	B	C	D	E	F	
XRFBP-3033AL	30	50	50	62	325	15	3
XRFBP-3044AL	30	60	60	62	335	15	3
XRFBP-3055AL	30	80	80	62	355	15	3
XRFBP-3066AL	30	100	100	62	375	15	3
XRFBP-3088AL	30	125	125	62	400	15	3
XRFBP-4044AL	40	60	60	67	345	15	3
XRFBP-4055AL	40	80	80	67	365	15	3
XRFBP-4066AL	40	100	100	67	382	15	3
XRFBP-4088AL	40	125	125	67	410	15	3
XRFBP-5044AL	50	60	60	75	355	15	3
XRFBP-5055AL	50	80	80	75	375	15	3
XRFBP-5066AL	50	100	100	75	395	15	3
XRFBP-5088AL	50	125	125	75	420	15	3
XRFBP-6044AL	60	60	60	80	360	15	3
XRFBP-6055AL	60	80	80	80	380	15	3
XRFBP-6066AL	60	100	100	80	400	15	3
XRFBP-6088AL	60	125	125	80	425	15	3



**BIMETALLIC EXPANSION L CONNECTOR GUIDED UNION CU. TUBE/STUD TO AL. FLATBAR**

**CONECTOR A 90° DE DILATACIÓN BIMETÁLICO GUIADO UNIÓN TUBO/BORNA CU. A PLETINA AL.**

**RACCORD EQUERRE SOUPLE BIMETALLIQUE GUIÉE JONCTION TUBE/BORNE CU. À BARRE MÉPLATE AL.**

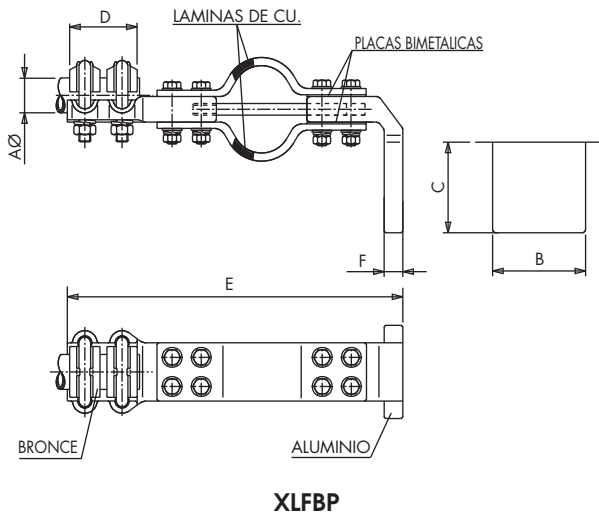

**XLFBP**

Referencia Code Référence	m m .						Par de apriete Tightening torque Couple de serrage (kg.m)
	A∅	B	C	D	E	F	
XLFBP-3033AL	30	50	50	62	325	15	3
XLFBP-3044AL	30	60	60	62	335	15	3
XLFBP-3055AL	30	80	80	62	355	15	3
XLFBP-3066AL	30	100	100	62	375	15	3
XLFBP-3088AL	30	125	125	62	400	15	3
XLFBP-4044AL	40	60	60	67	345	15	3
XLFBP-4055AL	40	80	80	67	365	15	3
XLFBP-4066AL	40	100	100	67	382	15	3
XLFBP-4088AL	40	125	125	67	410	15	3
XLFBP-5044AL	50	60	60	75	355	15	3
XLFBP-5055AL	50	80	80	75	375	15	3
XLFBP-5066AL	50	100	100	75	395	15	3
XLFBP-5088AL	50	125	125	75	420	15	3
XLFBP-6044AL	60	60	60	80	360	15	3
XLFBP-6055AL	60	80	80	80	380	15	3
XLFBP-6066AL	60	100	100	80	400	15	3
XLFBP-6088AL	60	125	125	80	425	15	3

**BIMETALLIC EXPANSION L CONNECTOR GUIDED UNION CU. TUBE/STUD TO AL. TUBE**

**CONECTOR A 90° DE DILATACIÓN BIMETÁLICO GUIADO UNIÓN TUBO/BORNA CU. A TUBO AL.**

**RACCORD EQUERRE SOUPLE BIMETALLIQUE GUIÉE JONCTION TUBE/BORNE CU. À TUBE AL.**

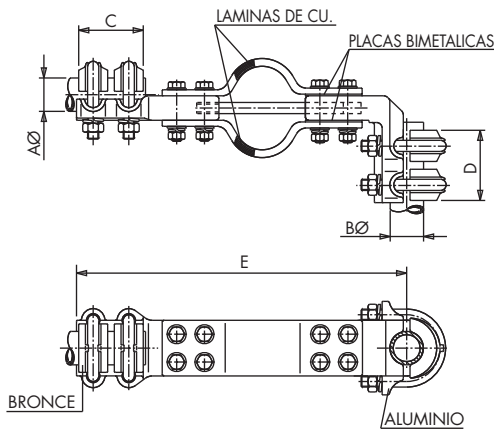

**XLFBB**

Referencia Code Référence	m m .					Par de apriete Tightening torque Couple de serrage (kg.m)
	A∅	B∅	C	D	E	
XLFBB-3030AL	30	30	62	67	298	3
XLFBB-3040AL	30	40	62	75	308	3
XLFBB-3050AL	30	50	62	80	318	3
XLFBB-4030AL	40	30	67	67	307	3
XLFBB-4040AL	40	40	67	75	317	3
XLFBB-4050AL	40	50	67	80	327	3
XLFBB-5030AL	50	30	75	67	325	3
XLFBB-5040AL	50	40	75	75	335	3
XLFBB-5050AL	50	50	75	80	345	3

**EXPANSION CONNECTORS (WITH FLEXIBLE COPPER SHEETS)**

**CONECTORES DE DILATACIÓN (CON LÁMINAS DE COBRE)**

**JONCTIONS SOUPLES (EN FEUILLARD CUIVRE)**

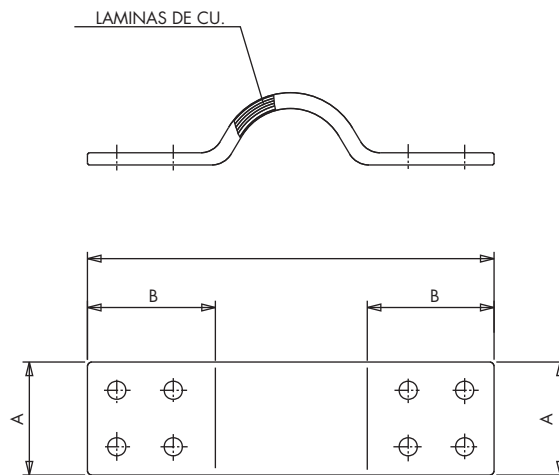

**FPP**

**EXPANSION CONNECTORS (WITH FLEXIBLE COPPER BRAIDS)**

**CONECTORES DE DILATACIÓN (CON TRENZAS DE COBRE)**

**JONCTIONS SOUPLES (AVEC TORON CUIVRE)**

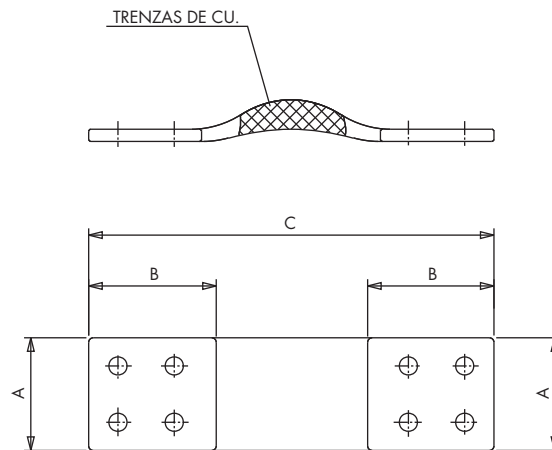

**TPP**

**NOTA: A INDICAR COTAS A,B,C, INTENSIDAD NOMINAL Y TALADROS**  
**NOTE: SPECIFY A,B,C, DIMENSIONS, NOMINAL INTENSITY AND DRILLINGS**  
**NOTE: PRECISER COTES A,B,C, INTENSITÉ NOMINAL ET PERCEGE**

